

CELO

**Hohlraum-
befestigungen**



Die Spezialisten bei Befestigungen in Plattenbaustoffen!

BT plus



4

FK



6

HRM



8

GKD



11

GKDZ



11

HR



14

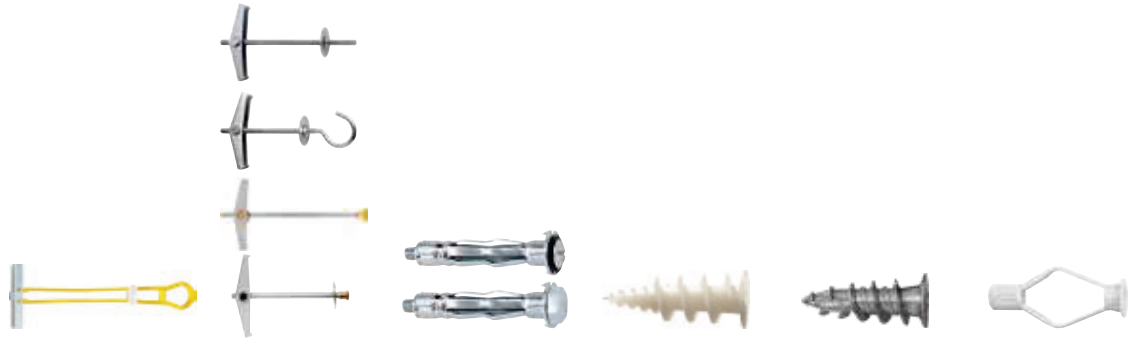

	BT plus	FK	HRM	GKD	GKDZ	HR
Material	Stahl Nylon u. PS	Stahl	Stahl	Nylon mit Glasfaser	Zinkdruckguss	Nylon
Geeignet für Plattenbaustoffe 	✓	✓	✓	✓ (nur Gipskartonplatten)	✓ (nur Gipskartonplatten)	✓
Geeignet für Lochsteine mit großen Kammern 	✓	✗	✓	✗	✗	✗
	✗	✗	✗	✓	✗	✓
Geeignete Plattenstärke	10-70 mm	1-65 mm	3-45 mm	12,5mm	bis 2x12,5 mm	3-16 mm
Leistung						
Zu verwenden mit Schraubentyp	metrische Schraube	✗	metrische Schraube	Spanplatten-schraube	Holz- oder Spanplatten-schraube metrische Schraube	Holz- oder Spanplatten-schraube
Zu verwenden mit Schraubendurchmesser	M4, M5, M6, M8	M3, M4	M4, M5, M6, M8	3,0 - 4,0	4,5 und M4	3,5 und 4,0
Montagezubehör	✗	✗	 Montagezange MZA	✗	✗	✗
 Im Blister erhältlich	✓	✓	✓	✓	✓	✓
Seite	4	6	8	11	11	14

Hohlraumdübel Universal BT plus



Vorteile

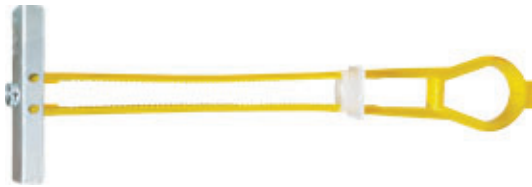

Universeller Hohlraumdübel mit hohen Haltewerten – einfach und schnell

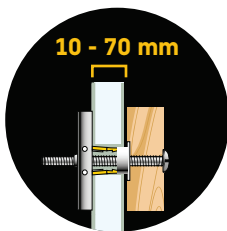

Universell einsetzbar
für **Plattendicken**
von **10-70 mm**



Hohe Haltewerte,
geeignet für Waschbecken,
Heizkörper oder
Hängeschränke



Montage ohne
Hilfswerkzeuge,
Zeitersparnis



Durchmesser-Kennzeichnung
auf der Metall-
Verankerungsschiene



Nicht brennbar nach DIN EN
13501-1, Klasse A1

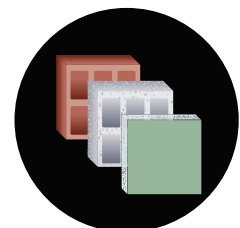

Geeignet für die Montage
in **Plattenbaustoffen,**
Lochsteinen oder
Hohldecken

Geeignete Baustoffe

Sehr gut geeignet



- Gipskartonplatten
- Spanplatten

Bedingt geeignet

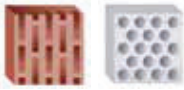

- Lochsteine mit großen Kammern
- Hohlkammerdecken

Zulassungen und Zertifikate



Montage

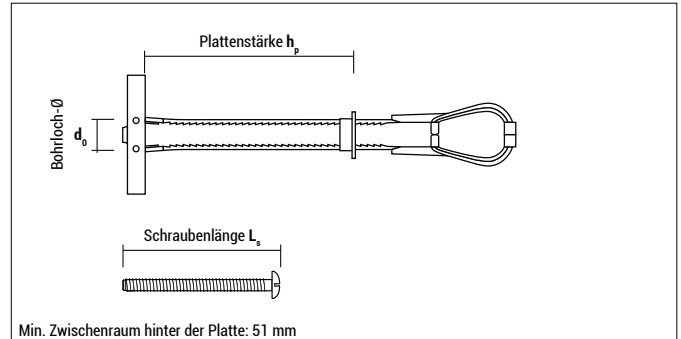
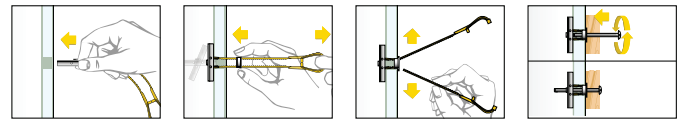

BT plus ohne Schraube

Typ	Art.-Nr.	d ₀ [mm]	h _{p min-max} [mm]	Gewinde [mm]	€ / 100 Stück	[Stück]	[Stück]
BT plus M4	9Y4BTP	13	10 - 70	M4		40	320
BT plus M5	9Y5BTP	13	10 - 70	M5		30	240
BT plus M6	9Y6BTP	13	10 - 70	M6		30	240
BT plus M8	9Y8BTP	18	10 - 70	M8		20	160



BT plus mit Schraube

Typ	Art.-Nr.	d ₀ [mm]	h _{p min-max} [mm]	Gewinde [mm]	L _s [mm]	Antrieb	€ / 100 Stück	[Stück]	[Stück]
BT plus M4 LO	9Y4BTPL0	13	10 - 70	M 4	50	PZ2 / Schlitz		40	320
BT plus M5 LO	9Y5BTPL0	13	10 - 70	M 5	62	PZ2 / Schlitz		30	240
BT plus M6 LO	9Y6BTPL0	13	10 - 70	M 6	62	PZ2 / Schlitz		30	240
BT plus M8 K	9Y8BTPK	18	10 - 70	M 8	60	SW13 / 6Kant		20	160



Blister BT plus mit Schraube



Typ	Art.-Nr.	d ₀ [mm]	h _{p min-max} [mm]	Gewinde	L _s [mm]	Antrieb	€ / Blister	[Stück]	[Blister]
BT M4 LO	54BTLO4	13	10 - 70	M4	50	PZ2 / Schlitz		4	10
BT M5 LO	55BTLO4	13	10 - 70	M5	62	PZ2 / Schlitz		4	10
BT M6 LO	56BTLO4	13	10 - 70	M6	62	PZ2 / Schlitz		4	10
BT M8 K	58BTK2	18	10 - 70	M8	60	Sechskant		2	10

Tragfähigkeiten F_{empf}

Typ	d ₀ [mm]	Zuglast N _{empf} in Gipskartonplatten				Querlast Q _{empf} in Gipskartonplatten			
		h _p = 9,5 mm [kN]	h _p = 12,5 mm [kN]	h _p = 2x9,5 mm [kN]	h _p = 2x12,5 mm [kN]	h _p = 9,5 mm [kN]	h _p = 12,5 mm [kN]	h _p = 2x9,5 mm [kN]	h _p = 2x12,5 mm [kN]
BT plus M4	13	0,07	0,15	0,15	0,30	0,20	0,20	0,25	0,30
BT plus M5	13	0,20	0,25	0,40	0,50	0,30	0,30	0,50	0,50
BT plus M6	13	0,20	0,25	0,40	0,50	0,30	0,30	0,50	0,50
BT plus M8	19	0,20	0,25	0,40	0,50	0,30	0,40	0,50	0,50

F_{empf}: Die empfohlenen Lasten inkl. Sicherheitsfaktor min. 3

Federklappdübel

FK



Vorteile



FK-S mit Unterlegscheibe und Sechskantmutter

FK-HS mit Rundhaken, Unterlegscheibe und Sechskantmutter

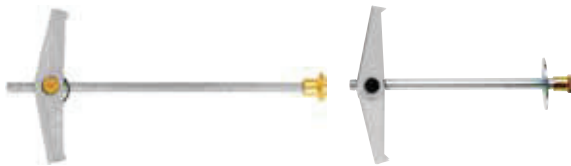

FK-R mit Rändelmutter gelb verzinkt

FK-UR mit Rändelmutter und Unterlegscheibe, gelb verzinkt

Spezialdübel für Hohlrumbefestigungen

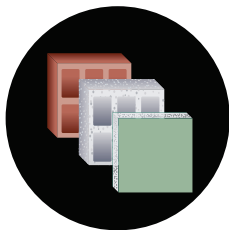

Geeignet für die Montage in **Plattenbaustoffen, Lochsteinen oder Hohldecken**



Vielfältige Anwendungen dank verschiedener Ausführungen



Erhältlich auch im praktischen Blister

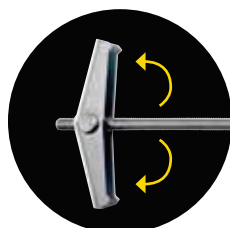

Der Dübel **klappt selbsttätig auf** und verankert hinter der Platte



Montage ohne Hilfswerkzeuge, **Zeitersparnis**

Geeignete Baustoffe

Sehr gut geeignet



- Hohldecken
- Hohlwände
- Gipskartonplatten
- Spanplatten

Montage

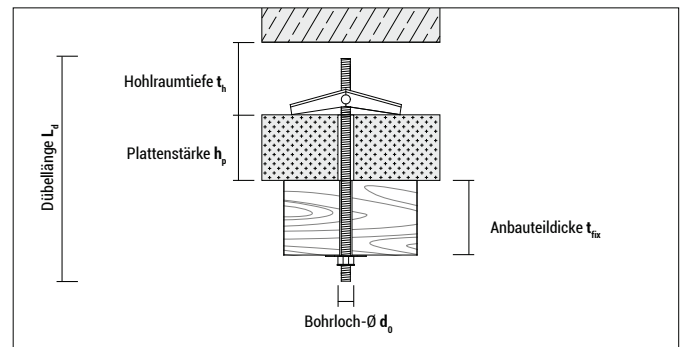
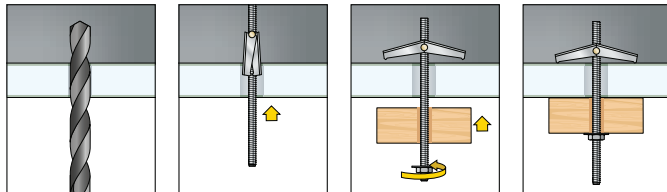

FK-S mit Unterlegscheibe und Sechskantmutter

Typ	Art.-Nr.	d ₀ [mm]	h _p + t _{fix} ≤ [mm]	Gewinde	L _d [mm]	t _h ≥ [mm]	€/ 100 Stück	[Stück]	[Stück]
3-85 S	9390FKS	11	65	M3	85	28		25	–
4-90 S	9495FKS	14	65	M4	90	35		25	–

FK-S mit Unterlegscheibe und Sechskantmutter

Typ	Art.-Nr.	d ₀ [mm]	h _p + t _{fix} ≤ [mm]	Gewinde	L _d [mm]	t _h ≥ [mm]	€/ 100 Stück	[Stück]	[Stück]
3-100 HS	9385FKHS	11	40	M3	100	28		25	–
4-95 HS	94100FKHS	14	30	M4	95	35		25	–

FK-R / FK-UR mit Rändelmutter gelb verzinkt

Typ	Art.-Nr.	d ₀ [mm]	h _p + t _{fix} ≤ [mm]	Gewinde	L _d [mm]	t _h ≥ [mm]	€/ 100 Stück	[Stück]	[Stück]
3-85 R	9390FKR	11	65	M3	85	28		25	–
4-90 R	9495FKR	14	65	M4	90	35		25	–
3-85 UR	9385FKUR	11	65	M3	85	28		25	–
4-90 UR	9490FKUR	14	65	M4	90	35		25	–



Blister FK-S mit Unterlegscheibe und Sechskantmutter

Blister FK-HS mit Rundhaken, Unterlegscheibe und Sechskantmutter



Typ	Art.-Nr.	d ₀ [mm]	h _p + t _{fix} ≤ [mm]	Gewinde	L _d [mm]	t _h ≥ [mm]	€/ Blister	[Stück]	[Blister]
FK-S 3 x 85	5390FKS2	11	65	M3	85	28		2	10
FK-S 4 x 90	5495FKS2	14	65	M4	90	35		2	10
FK-HS 3 x 100	5385FKHS2	11	40	M3	100	28		2	10
FK-HS 4 x 95	54100FKHS2	14	30	M4	95	35		2	10

Tragfähigkeiten F_{empf} FK-S, FK-R, FK-UR

Typ	Gipskarton h _p = 12,5 mm F _{empf} [kN]	Holzspanplatte h _p = 13 mm F _{empf} [kN]	Faserzementplatten h _p = 10 mm F _{empf} [kN]
M3: FK-S, FK-R, FK-UR	0,15	0,25	0,25
M4: FK-S, FK-R, FK-UR	0,15	0,36	0,45

F_{empf}: Die empfohlenen Lasten inkl. Sicherheitsfaktor 4

Tragfähigkeiten F_{empf} FK-HS mit Winkelhaken

Typ	Gipskarton h _p = 12,5 mm F _{empf} [kN]	Holzspanplatte h _p = 13 mm F _{empf} [kN]	Faserzementplatten h _p = 10 mm F _{empf} [kN]
M3: FK-HS	0,06*	0,06*	0,06*
M4: FK-HS	0,15*	0,15*	0,15*

F_{empf}: Die empfohlenen Lasten inkl. Sicherheitsfaktor 4

* Aufbiegen des Hakens ist maßgebend.

Hohlraum- dübel HRM



Vorteile



HRM 4, 5, 6

HRM 8

Metall-Spezialdübel für schwere Hohlraumbefestigungen



Ideal für die Montage von Küchenschränken oder Regalen

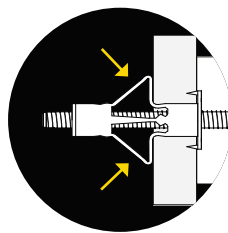

Der Dübel spreizt sich großflächig ab und erreicht dadurch **hohe Haltewerte**



Schnelle und sichere Montage mit **Setzspanne MZA 100** (Akkuschrauber und Schraubendreher möglich)



Nicht brennbar nach DIN EN 13501-1, Klasse A1

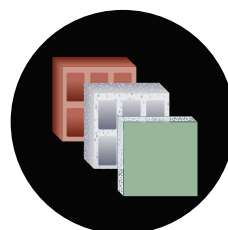

Geeignet für die Montage in **Plattenbaustoffen, Lochsteinen oder Hohldecken**

Geeignete Baustoffe

Sehr gut geeignet



- Hohldecken
- Hohlwände
- Gipskarton/-faserplatten
- Spanplatten

Bedingt geeignet

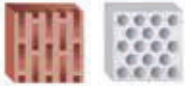

- Lochsteine mit großen Kammern

Montage

Montage mit Montagezange (empfohlen)

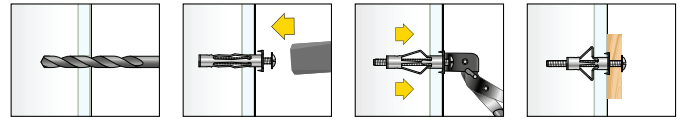

Montage ohne Montagezange

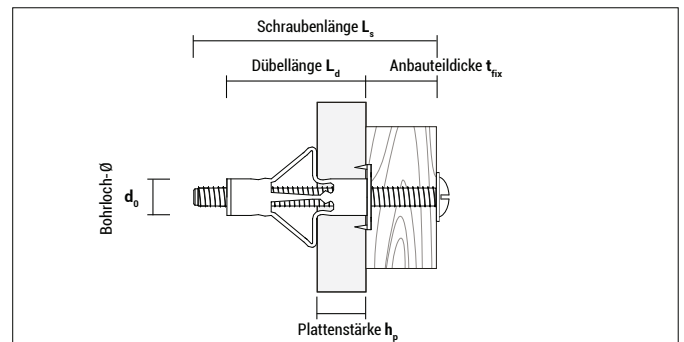
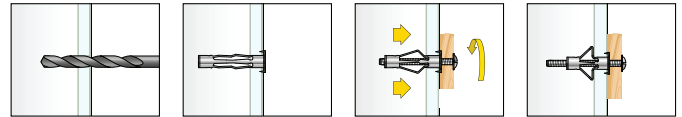

Montagezange MZA 100 für HRM



Typ	Art.-Nr.	€/Stück	[Stück]	[Stück]
MZA 100	9MZA00		1	-



HRM

	Typ	Art.-Nr.	d ₀ [mm]	h _p min-max [mm]	Gewinde	L _s [mm]	L _d [mm]	t _{fix} [mm]	€/100 Stück	[Stück]	[Stück]
Kleinpackung (Fensterschachtel)	HRM 4-20	9420HRM50	8	3 - 18	M4	52	46	43 - 28		50	1.350
	HRM 4-24	9424HRM50	8	18 - 24	M4	58	52	34 - 28		50	1.350
	HRM 4-38	9438HRM50	8	32 - 38	M4	72	66	34 - 28		50	1.350
	HRM 5-16	9516HRM50	11	3 - 16	M5	58	52	49 - 36		50	1.350
	HRM 5-32	9532HRM25	11	14 - 32	M5	71	65	51 - 33		25	675
	HRM 5-45	9545HRM25	11	32 - 45	M5	88	80	48 - 35		25	675
	HRM 6-16	9616HRM25	13	3 - 16	M6	58	52	49 - 36		25	675
	HRM 6-32	9632HRM25	13	14 - 32	M6	71	65	51 - 33		25	675
	HRM 6-45	9645HRM25	13	32 - 45	M6	88	80	48 - 35		25	675
	HRM 8-16*	9816HRM25	13	3 - 16	M8	61	53	50 - 37		25	675
HRM 8-32*	9832HRM20	13	16 - 32	M8	73	66	50 - 34		20	540	
Großpackung	HRM 4-20	9420HRM	8	3 - 18	M4	52	46	43 - 28		100	1.000
	HRM 4-24	9424HRM	8	18 - 24	M4	58	52	34 - 28		100	1.000
	HRM 4-38	9438HRM	8	32 - 38	M4	72	66	34 - 28		100	1.000
	HRM 5-16	9516HRM	11	3 - 16	M5	58	52	49 - 36		100	500
	HRM 5-32	9532HRM	11	14 - 32	M5	71	65	51 - 33		100	500
	HRM 5-45	9545HRM	11	32 - 45	M5	88	80	48 - 35		100	900
	HRM 6-16	9616HRM	13	3 - 16	M6	58	52	49 - 36		100	500
	HRM 6-32	9632HRM	13	14 - 32	M6	71	65	51 - 33		100	900
	HRM 6-45	9645HRM	13	32 - 45	M6	88	80	48 - 35		100	600
	HRM 8-16*	9816HRM	13	3 - 16	M8	61	53	50 - 37		100	300
HRM 8-32*	9832HRM	13	16 - 32	M8	73	66	50 - 34		100	300	

* Sechskantschraube, SW 13



Blister HRM

Typ	Art.-Nr.	d ₀ [mm]	h _p min-max [mm]	Gewinde	L _s [mm]	L _d [mm]	Schraubentyp	€/Blister	[Stück]	[Blister]
4-20	5420HRM5	8	3 - 18	M4	52	46			5	10
4-24	5424HRM5	8	18 - 24	M4	58	52			5	10
5-16	5516HRM5	11	3 - 16	M5	58	52			5	10
5-16 RH	5516HRMRH4	11	3 - 16	M5	58	52			4	10
5-16 WH	5516HRMWH4	11	3 - 16	M5	58	52			4	10
5-32	5532HRM5	11	14 - 32	M5	71	65			5	10
5-32 RH	5532HRMRH4	11	14 - 32	M5	71	65			4	10
5-32 WH	5532HRMWH4	11	14 - 32	M5	71	65			4	10
6-16	5616HRM5	13	3 - 16	M6	58	52			5	10
6-32	5632HRM5	13	14 - 32	M6	71	65			5	10

Tragfähigkeiten F_{empf}

Typ	Sperrholz		Gipskarton			
	6 mm F _{empf} [kN]	16 mm F _{empf} [kN]	h _p =9,5 mm F _{empf} [kN]	h _p =12,5 mm F _{empf} [kN]	h _p =2 x 12,5 mm F _{empf} [kN]	h _p =3 x 12,5 mm F _{empf} [kN]
HRM 4-20	0,15	0,25	0,15	0,15	-	-
HRM 4-24	-	-	-	-	0,15	-
HRM 4-38	-	-	-	-	-	0,25
HRM 5-16	0,20	0,25	0,20	0,20	-	-
HRM 5-32	-	-	-	-	0,35	-
HRM 5-45	-	-	-	-	-	0,35
HRM 6-16	0,25	0,30	0,25	0,25	-	-
HRM 6-32	-	-	-	-	0,35	-
HRM 6-45	-	-	-	-	-	0,40
HRM 8-16	0,30	0,40	0,25	0,25	-	-
HRM 8-32	-	-	-	-	0,40	-

F_{empf}: Empfohlene Last inkl. Sicherheitsfaktor 3

Gipskarton- dübel GKD & GKDZ



Vorteile



GKD aus Nylon (glasfaserverstärkt)



GKDZ 37 aus Zinkdruckguss

Selbstbohrender Dübel für die schnelle Montage in Gipskarton

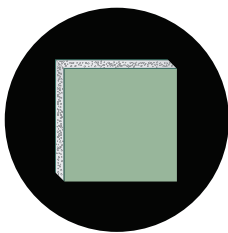

Der Spezialist für
**Gipskartonplatten und
Gipsfaserplatten [GKDZ]**



Selbstbohrender Dübel
mit scharfer Bohrspitze



Enorme Zeitersparnis
durch die Direktbefesti-
gung ohne Vorbohren



GKD aus **glasfaserverstärktem
Nylon**, alterungs-, witterungs-
und UV-beständig

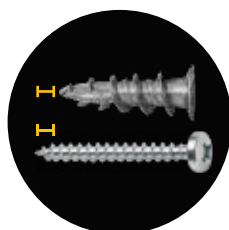

Wenn die Schraube länger als der
Dübel [GKD oder GKDZ] ist,
**schraubt sie sich einfach durch die
Dübelspitze**

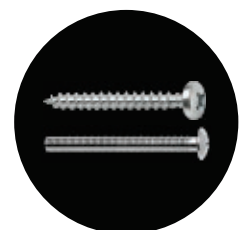

Zu verwenden mit
Spanlatteschrauben;
GKDZ auch mit **metrischen
Schrauben M4**

Geeignete Baustoffe

Sehr gut geeignet



- Gipskartonplatten

Bedingt geeignet

- Gipsfaserplatten

Zulassungen und Zertifikate



Montage GKD

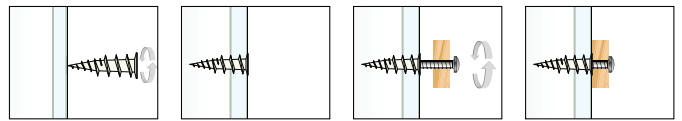

Montage GKDZ

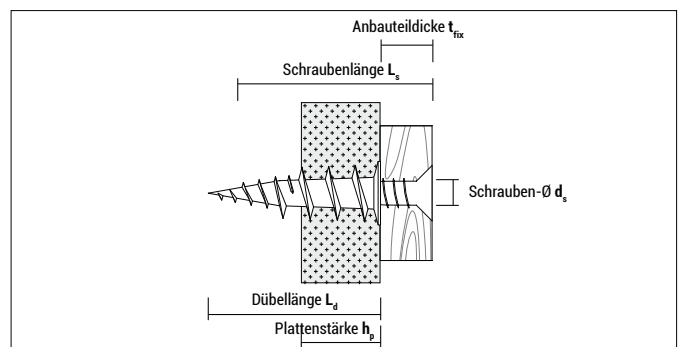
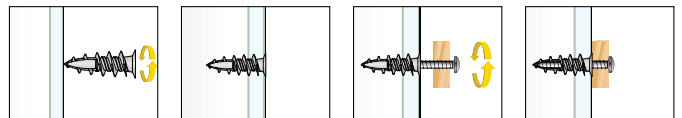

GKD ohne Schraube, Dübelantrieb: PH 2

Typ	Art.-Nr.	L_d [mm]	h_p [mm]	d_s min-max [mm]	$L_s \geq$ [mm]	€ / 100 Stück	[Stück]	[Stück]
GKD	9GKD	35	9 - 12,5	3 - 4,5	$22 + t_{fix}$		50	2.400



GKD mit Schraube 4,0 x 40, Dübelantrieb: PH 2

Typ	Art.-Nr.	L_d [mm]	h_p [mm]	$d_s \times L_s$ [mm]	$t_{fix} \leq$ [mm]	€ / 100 Stück	[Stück]	[Stück]
GKD PZ	9GKDPZ	35	9 - 12,5	4,0 x 40	18		50	2.400



GKDZ ohne Schraube, Dübelantrieb: PH 2 / PZ 2

Typ	Art.-Nr.	L_d [mm]	$h_{p, min}$ [mm]	d_s min-max [mm]	$L_s \geq$ [mm]	€ / 100 Stück	[Stück]	[Stück]
GKDZ 37*	937GKDZ	37	9	4,5	$19 + t_{fix}$		100	2.700
GKDZ 37	937GKDZ50	37	9	4,5	$19 + t_{fix}$		50	2.400

* Großpack, (ohne Fensterschachtel)



GKDZ mit Schraube 4,5 x 35, Dübelantrieb: PH 2 / PZ 2

Typ	Art.-Nr.	L_d [mm]	$h_{p, min}$ [mm]	$d_s \times L_s$ [mm]	$t_{fix} \leq$ [mm]	€ / 100 Stück	[Stück]	[Stück]
GKDZ 37 PZ	937GKDZPZ50	37	9	4,5 x 35	16		50	2.400



Blister GKD ohne Schraube

Typ	Art.-Nr.	L_d [mm]	h_p [mm]	$d_{s, \text{min-max}}$ [mm]	L_s [mm]	€ / Blister	[Stück]	[Blister]
GKD	5GKD10	35	9 - 12,5	3 - 4,5	$22 + t_{\text{fix}}$		10	10



Blister GKD mit Schraube

Typ	Art.-Nr.	L_d [mm]	h_p [mm]	$d_s \times L_s$ [mm]	Schraubentyp	€ / Blister	[Stück]	[Blister]
GKD PZ	5GKDPZ6	35	9 - 12,5	4,0 x 40			6	10



Blister GKDZ ohne Schraube

Typ	Art.-Nr.	L_d [mm]	$h_{p, \text{min}}$ [mm]	$d_{s, \text{min-max}}$ [mm]	L_s [mm]	€ / Blister	[Stück]	[Blister]
GKDZ 37	537GKDZ10	37	9	4,5	$19 + t_{\text{fix}}$		10	10



Blister GKDZ mit Schraube

Typ	Art.-Nr.	L_d [mm]	$h_{p, \text{min}}$ [mm]	$d_s \times L_s$ [mm]	Schraubentyp	€ / Blister	[Stück]	[Blister]
GKDZ 37 PZ	537GKDZSZ6	37	9	4,5 x 35			6	10

Tragfähigkeiten F_{empf}

Typ	Gipskarton $h_p = 12,5 \text{ mm}$		Gipskarton $h_p \geq 2 \times 12,5 \text{ mm}$
	F_{empf} [kN]		F_{empf} [kN]
GKD	0,07		–
GKDZ 37	0,08		0,16

F_{empf} : Empfohlene Last inkl. Sicherheitsfaktor 4

Hohlraum- dübel HR



Vorteile



Spezialdübel für leichte Hohlrumbaefestigungen

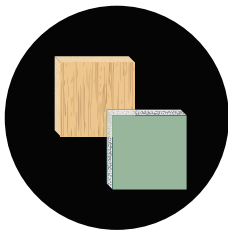

Geeignet für die Befestigung in **Plattenbaustoffen**



Kostengünstige Befestigung bei leichten Lasten

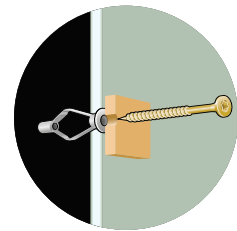

Montage mit Holz- oder Spanplattenschrauben durch vorhandenes Gewinde im Dübel



Dübel aus **hochqualitativem Nylon**, alterungs-, witterungs- und UV-beständig



Erhältlich auch im praktischen Blister

Geeignete Baustoffe

Sehr gut geeignet



- Gipskarton/-faserplatten
- Spanplatten

Zulassungen und Zertifikate



Montage

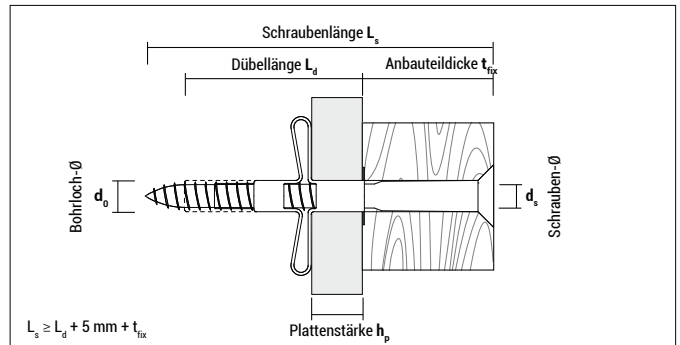
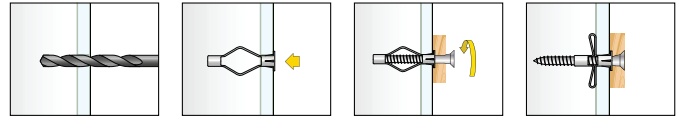

HR



Typ	Art.-Nr.	d ₀ [mm]	h _p min-max [mm]	d _s [mm]	L _d [mm]	€/ 100 Stück	[Stück]	[Stück]
HR 6-30	9630HR	6	3 - 14	3,5	30		100	4.800
HR 8-40	9840HR	8	10 - 16	4,0	40		50	2.400



Blister HR

Typ	Art.-Nr.	d ₀ [mm]	h _p min-max [mm]	d _s x L _s [mm]	L _d [mm]	€/ Blister	[Stück]	[Blister]
HR 6-30 SPS	56HRSZ20	6	3 - 14	3,5 x 50	30		20	10
HR 8-40 SPS	58HRSZ20	8	10 - 16	4,0 x 60	40		20	10

Tragfähigkeiten F_{empf}

Typ	Sperrholz 6 mm	Spanplatten 16 mm	Gipskarton	
	F _{empf} [kN]	F _{empf} [kN]	h _p = 9,5 mm F _{empf} [kN]	h _p = 12,5 mm F _{empf} [kN]
HR 6-30	0,10	–	0,08	0,08
HR 8-40	–	0,15	–	0,10

F_{empf}: Empfohlene Last inkl. Sicherheitsfaktor 3



CELO Befestigungssysteme GmbH
Industriestraße 6
D-86551 Aichach
www.celofixings.com
Hotline: +49 (0) 8251-90485-0
Telefax: +49 (0) 8251-90485-49
E-mail: info@celofixings.de

Small Things Matter

Überreicht durch: