

Approval body for construction products
and types of construction

Bautechnisches Prüfamt

An institution established by the Federal and
Laender Governments



European Technical Assessment

ETA-16/0470
of 16 July 2021

English translation prepared by DIBt - Original version in German language

General Part

Technical Assessment Body issuing the
European Technical Assessment:

Deutsches Institut für Bautechnik

Trade name of the construction product

CELO Concrete screw BTS

Product family
to which the construction product belongs

Mechanical fasteners for use in concrete

Manufacturer

CELO Befestigungssysteme GmbH
Industriestraße 6
86551 Aichach
DEUTSCHLAND

Manufacturing plant

Werk 16

This European Technical Assessment
contains

22 pages including 3 annexes which form an integral part
of this assessment

This European Technical Assessment is
issued in accordance with Regulation (EU)
No 305/2011, on the basis of

EAD 330232-00-0601, Edition 10/2016

This version replaces

ETA-16/0470 issued on 6 October 2016

The European Technical Assessment is issued by the Technical Assessment Body in its official language. Translations of this European Technical Assessment in other languages shall fully correspond to the original issued document and shall be identified as such.

Communication of this European Technical Assessment, including transmission by electronic means, shall be in full. However, partial reproduction may only be made with the written consent of the issuing Technical Assessment Body. Any partial reproduction shall be identified as such.

This European Technical Assessment may be withdrawn by the issuing Technical Assessment Body, in particular pursuant to information by the Commission in accordance with Article 25(3) of Regulation (EU) No 305/2011.

Specific Part

1 Technical description of the product

The CELO concrete screw BTS is an anchor in size 6, 8, 10, 12 and 14 mm made of galvanised steel respectively steel with zinc flake coating, made of stainless or high corrosion resistant steel. The anchor is screwed into a predrilled cylindrical drill hole. The special thread of the anchor cuts an internal thread into the member while setting. The anchorage is characterised by mechanical interlock in the special thread.
 The product description is given in Annex A.

2 Specification of the intended use in accordance with the applicable European Assessment Document

The performances given in Section 3 are only valid if the anchor is used in compliance with the specifications and conditions given in Annex B.
 The verifications and assessment methods on which this European Technical Assessment is based lead to the assumption of a working life of the anchor of at least 50 years. The indications given on the working life cannot be interpreted as a guarantee given by the producer, but are to be regarded only as a means for choosing the right products in relation to the expected economically reasonable working life of the works.

3 Performance of the product and references to the methods used for its assessment

3.1 Mechanical resistance and stability (BWR 1)

Essential characteristic	Performance
Characteristic resistance to tension load (static and quasi-static loading)	See Annex C 1 and C 2
Characteristic resistance to shear load (static and quasi-static loading)	See Annex C 1 and C 2
Displacements (static and quasi-static loading)	See Annex C 7
Characteristic resistance and displacements for seismic performance categories C1 and C2	See Annex C 3, C 4, C 5 and C 8
Durability	See Annex B 1

3.2 Safety in case of fire (BWR 2)

Essential characteristic	Performance
Reaction to fire	Class A1
Resistance to fire	See Annex C 6

English translation prepared by DIBt

4 Assessment and verification of constancy of performance (AVCP) system applied, with reference to its legal base

In accordance with European Assessment Document EAD No. 330232-00-0601 the applicable European legal act is: [96/582/EC].

The system to be applied is: 1

5 Technical details necessary for the implementation of the AVCP system, as provided for in the applicable European Assessment Document

Technical details necessary for the implementation of the AVCP system are laid down in the control plan deposited at Deutsches Institut für Bautechnik.

Issued in Berlin on 16 July 2021 by Deutsches Institut für Bautechnik

Dipl.-Ing. Beatrix Wittstock
Head of Section

beglaubigt:
Baderschneider

Product in installed condition

CELO concrete screw BTS

- Galvanized carbon steel
- Zinc flakes coated carbon steel

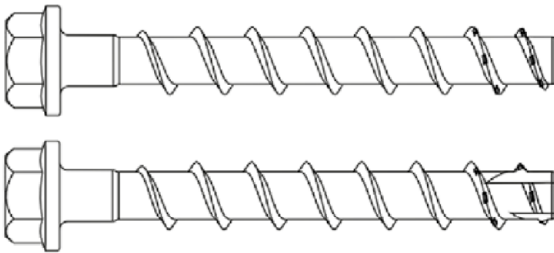

- Stainless steel A4
- Stainless steel HCR

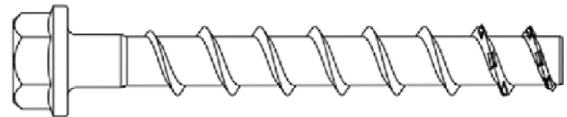

e.g. CELO concrete screw, zinc flakes coated, with hexagon head and fixture

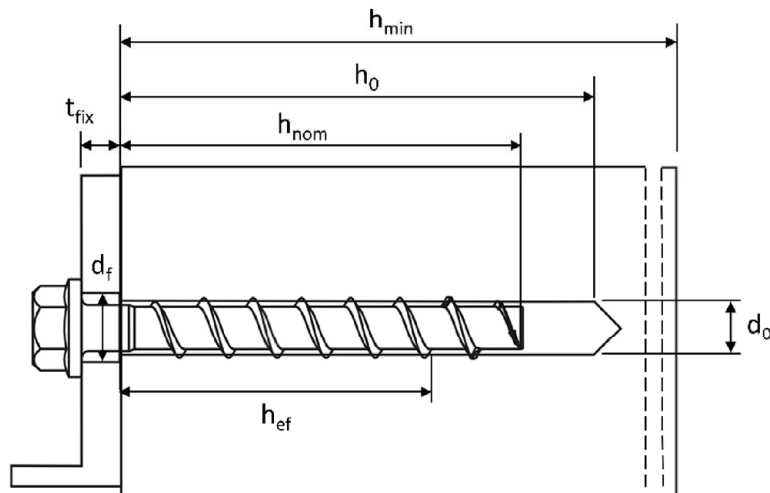

d_0 = nominal drill hole diameter

t_{fix} = thickness of fixture

d_f = clearance hole diameter

h_{min} = minimum thickness of member

h_{nom} = nominal embedment depth

h_0 = drill hole depth

h_{ef} = effective embedment depth



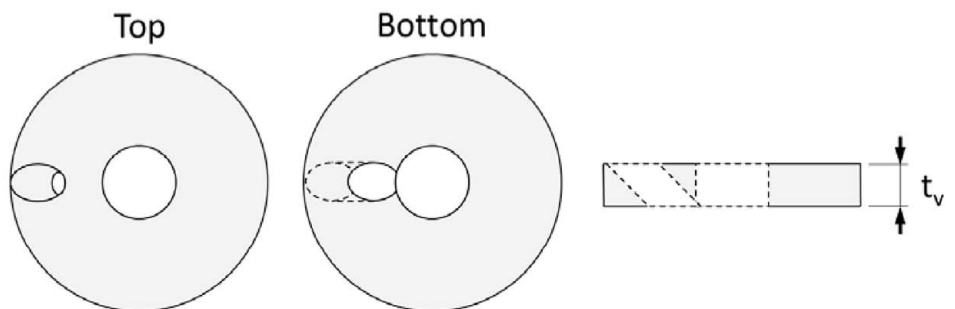







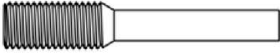



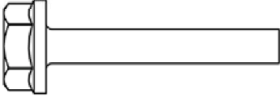

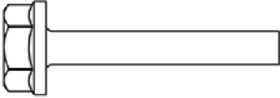

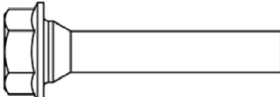

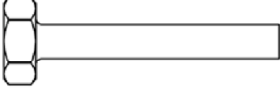

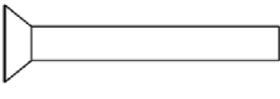

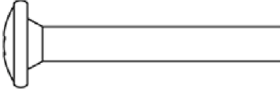
Filling washer (optional)
to fill annular gap

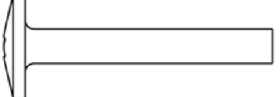

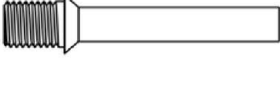
CELO concrete screw BTS

Product description
Product in installed condition

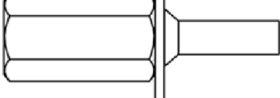
Annex A1

		Configuration with metric connection thread and hexagon socket e.g. BTS 8x105 M10 IN5
		Configuration with metric connection thread and hexagon drive e.g. BTS 8x105 M10 SW7
		Configuration with washer and hexagon head e.g. BTS B 8x80 SW13
		Configuration with washer, hexagon head and TORX drive e.g. BTS B 8x80 SW13 TX40
		Configuration with washer and underhead reinforcement e.g. BTS M 14x130 SW24
		Configuration with hexagon head e.g. BTS K 8x80 SW13
		Configuration with countersunk head and TORX drive e.g. BTS ST 8x80 TX40
		Configuration with pan head and TORX drive e.g. BTS PT 8x80 TX40
		Configuration with large pan head and TORX drive e.g. BTS PLT 8x80 TX40
		Configuration with countersunk head and connection thread e.g. BTS E 6x55 M8
		Configuration with hexagon drive and connection thread e.g. BTS E 6x55 M8 SW10
		Configuration with internal thread and hexagon drive e.g. BTS H 6x55 M8/10
CELO concrete screw BTS		Annex A2
Product description Screw types		

English translation prepared by DIBt

Table 1: Material

Part	Product name	Material
all types	CELO BTS	- Steel EN 10263-4:2017 galvanized acc. to EN ISO 4042:2018 - Zinc flake coating according to EN ISO 10683:2018 ($\geq 5\mu\text{m}$) - Zinc flake coating according to EN ISO 10683:2018 special coating KORR ($\geq 20\mu\text{m}$)
	CELO BTS A4	1.4401; 1.4404; 1.4571; 1.4578
	CELO BTS HCR	1.4529

Part	Product name	Nominal characteristic steel		Rupture elongation A_5 [%]
		Yield strength f_{yk} [N/mm ²]	Ultimate strength f_{uk} [N/mm ²]	
all types	CELO BTS	560	700	≤ 8
	CELO BTS A4			
	CELO BTS HCR			

Table 2: Dimensions

Anchor size			6		8			10			12			14		
Nominal embedment depth	h_{nom}	[mm]	1	2	1	2	3	1	2	3	1	2	3	1	2	3
		[mm]	40	55	45	55	65	55	75	85	65	85	100	75	100	115
Screw length	$\leq L$	[mm]	500													
Core diameter	d_k	[mm]	5,1		7,1			9,1			11,1			13,1		
Thread outer diameter	d_s	[mm]	7,5		10,6			12,6			14,6			16,6		
Thickness of filling washer	t_v	[mm]	-		5			5			5			5		

Marking:

BTS

Screw type: BTS
Screw size: 10
Screw length: 100



BTS M

Screw type: BTS M
Screw size: 10
Screw length: 100



BTS A4

Screw type: BTS
Screw size: 10
Screw length: 100
Material: A4

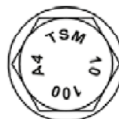

BTS HCR

Screw type: BTS
Screw size: 10
Screw length: 100
Material: HCR

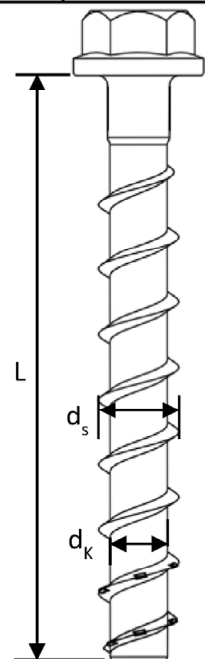

CELO concrete screw BTS

Product description

Material, Dimensions and markings

Annex A3

Specification of Intended use

Table 3: Anchorages subject to

BTS concrete screw size		6		8			10			12			14		
Nominal embedment depth		h_{nom1}	h_{nom2}	h_{nom1}	h_{nom2}	h_{nom3}	h_{nom1}	h_{nom2}	h_{nom3}	h_{nom1}	h_{nom2}	h_{nom3}	h_{nom1}	h_{nom2}	h_{nom3}
	[mm]	40	55	45	55	65	55	75	85	65	85	100	65	85	115
Static and quasi-static loads		All sizes and all embedment depths													
Fire exposure		All sizes and all embedment depths													
C1 category - seismic		ok	ok				ok								
C2 category – seismic (A4 and HCR: no performance assessed)		1)		1)		ok	1)	1)	ok	1)		ok	1)		ok

¹⁾ no performance assessed

Base materials:

- Compacted reinforced and unreinforced concrete without fibers according to EN 206:2013.
- Strength classes C20/25 to C50/60 according to EN 206:2013.
- Cracked and uncracked concrete.

Use conditions (Environmental conditions):

- Concrete screws subject to dry internal conditions: all screw types.
- Structural subject to external atmospheric exposure (including industrial and marine environment) and to permanently damp internal condition no particular aggressive conditions exists: screw types made of stainless steel with marking A4.
- Structural subject to external atmospheric exposure (including industrial and marine environment) and to permanently damp internal condition if particular aggressive conditions exists: screw types made of stainless steel with marking HCR.

Note: Such particular aggressive conditions are e.g. permanent, alternating immersion in seawater or splash zone of seawater, chloride atmosphere of indoor swimming pools or atmosphere with chemical pollution (e.g. in desulphurization plants or road tunnels where de-icing materials are used).

CELO concrete screw BTS

**Intended use
Specification**

Annex B1

Specification of Intended use - continuation

Design:

- Anchorages are to be designed under the responsibility of an engineer experienced in anchorages and concrete work.
- Verifiable calculation notes and drawings are to be prepared taking account of the loads to be anchored. The position of the anchor is indicated on the design drawings (e.g. position of the anchor relative to reinforcement or to supports, etc.).
- Anchorages are designed according to EN 1992-4:2018 and EOTA Technical Report TR 055. The design for shear load according to EN 1992-4:2018, Section 6.2.2 applies for all specified diameters d_f of clearance hole in the fixture in Annex B3, Table 4.

Installation:

- Hammer drilling or hollow drilling.
- Anchor installation carried out by appropriately qualified personnel and under the supervision of the person responsible for technical matters on site.
- In case of aborted hole: new drilling must be drilled at a minimum distance of twice the depth of aborted hole or closer, if the aborted hole is filled with high strength mortar and only if the hole is not in the direction of the oblique tensile or shear load.
- After installation further turning of the anchor must not be possible. The head of the anchor is supported in the fixture and is not damaged.
- The borehole may be filled with injection mortar CF-T 300V or ATA 2004C.
- Adjustability according to Annex B6 for sizes 6-14, all embedment depths except for seismic application.
- Cleaning of borehole is not necessary, if using a hollow drill.

CELO concrete screw BTS

Intended use
Specification continuation

Annex B2

Table 4: Installation parameters

BTS concrete screw size		6		8			10		
Nominal embedment depth	h_{nom}	h_{nom1}	h_{nom2}	h_{nom1}	h_{nom2}	h_{nom3}	h_{nom1}	h_{nom2}	h_{nom3}
	[mm]	40	55	45	55	65	55	75	85
Nominal drill hole diameter	d_0	6		8			10		
Cutting diameter of drill bit	$d_{cut} \leq$	6,40		8,45			10,45		
Drill hole depth	$h_0 \geq$	45	60	55	65	75	65	85	95
Clearance hole diameter	$d_f \leq$	8		12			14		
Installation torque (version with connection thread)	T_{inst}	10		20			40		
Torque impact screw driver	[Nm]	Max. torque according to manufacturer's instructions							
		160		300			400		

BTS concrete screw size		12			14		
Nominal embedment depth	h_{nom}	h_{nom1}	h_{nom2}	h_{nom3}	h_{nom1}	h_{nom2}	h_{nom3}
	[mm]	65	85	100	75	100	115
Nominal drill hole diameter	d_0	12			14		
Cutting diameter of drill bit	$d_{cut} \leq$	12,50			14,50		
Drill hole depth	$h_0 \geq$	75	95	110	85	110	125
Clearance hole diameter	$d_f \leq$	16			18		
Installation torque (version with connection thread)	T_{inst}	60			80		
Torque impact screw driver	[Nm]	Max. torque according to manufacturer's instructions					
		650			650		

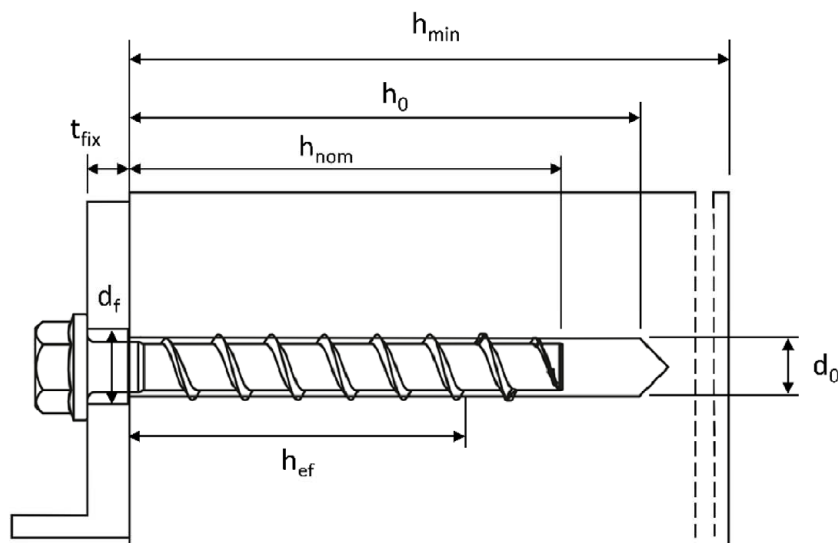

CELO concrete screw BTS

Intended use
Installation parameters

Annex B3

Table 5: Minimum thickness of member, minimum edge distance and minimum spacing

BTS concrete screw size		6			8			10		
Nominal embedment depth	h_{nom}	h_{nom1}	h_{nom2}	h_{nom1}	h_{nom2}	h_{nom3}	h_{nom1}	h_{nom2}	h_{nom3}	
	[mm]	40	55	45	55	65	55	75	85	
Minimum thickness of member	h_{min}	[mm]	100	100		120	100	130		
Minimum edge distance	c_{min}	[mm]	40	40	50		50			
Minimum spacing	s_{min}	[mm]	40	40	50		50			

BTS concrete screw size		12			14			
Nominal embedment depth	h_{nom}	h_{nom1}	h_{nom2}	h_{nom3}	h_{nom1}	h_{nom2}	h_{nom3}	
	[mm]	65	85	100	75	100	115	
Minimum thickness of member	h_{min}	[mm]	120	130	150	130	150	170
Minimum edge distance	c_{min}	[mm]	50		70	50	70	
Minimum spacing	s_{min}	[mm]	50		70	50	70	

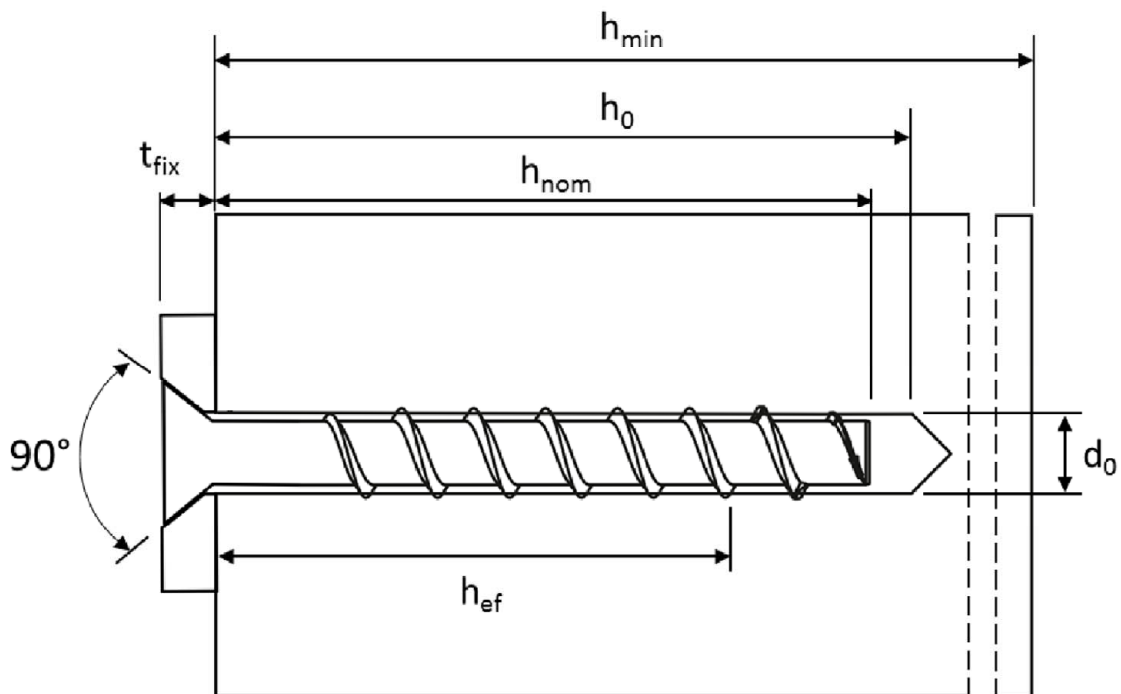

CELO concrete screw BTS

Intended use

Minimum thickness of member, minimum edge distance and minimum spacing

Annex B4

Installation Instructions

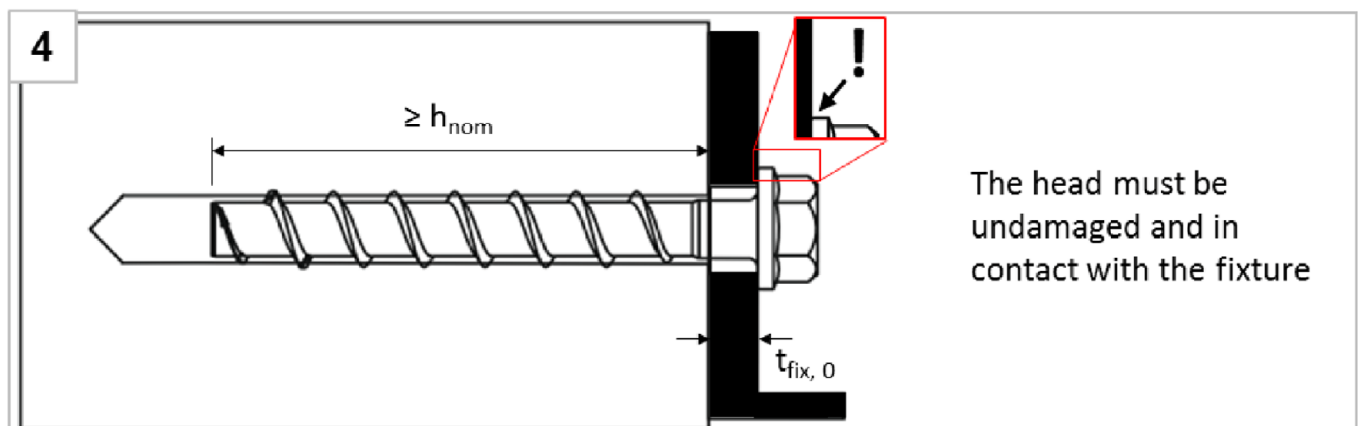
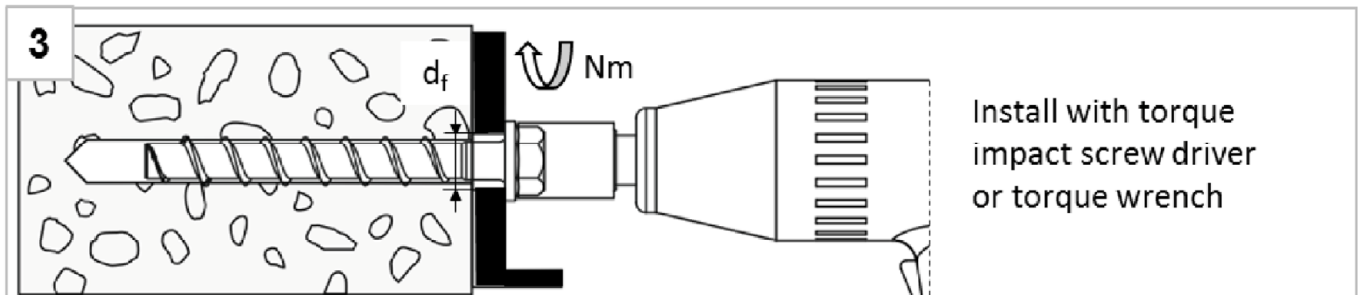
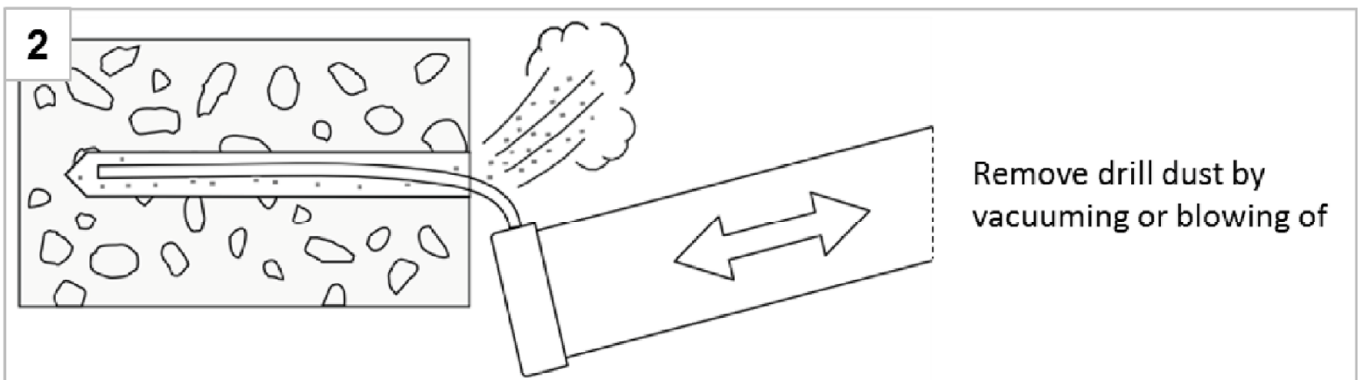
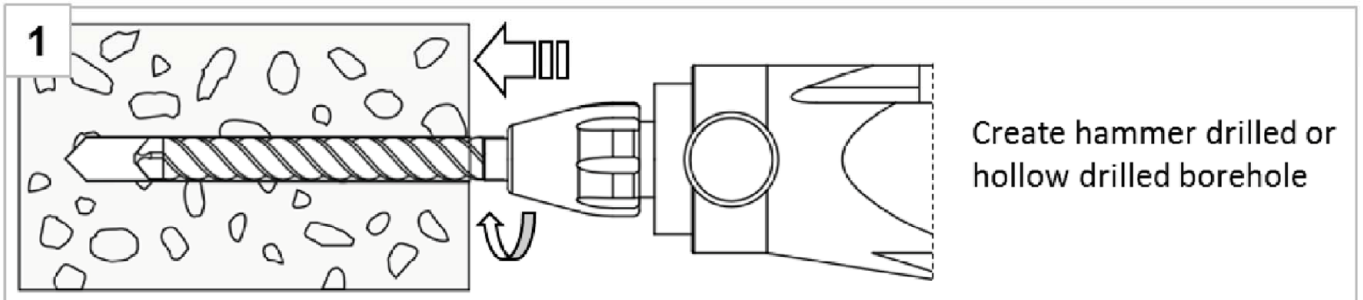

Note:

Cleaning of borehole is not necessary when using a hollow drill

CELO concrete screw BTS

Intended use
Installation instructions

Annex B5

Installation Instructions – Adjustment

1. Adjustment

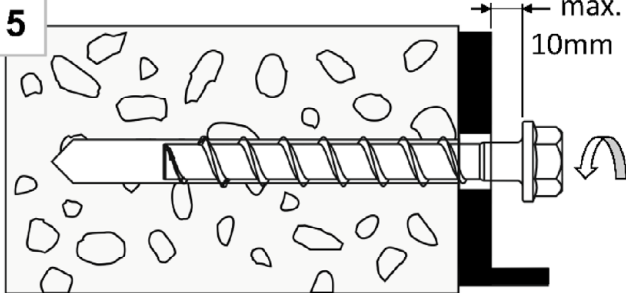

Screw may be untightened maximum 10mm

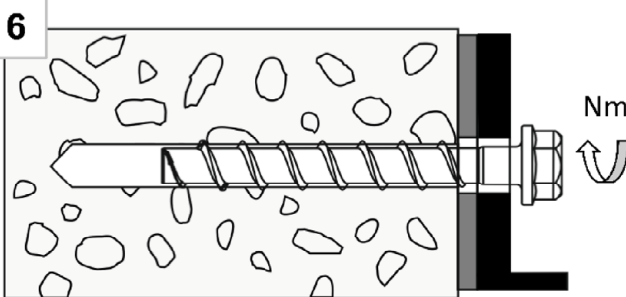

After adjustment, tighten the screw again

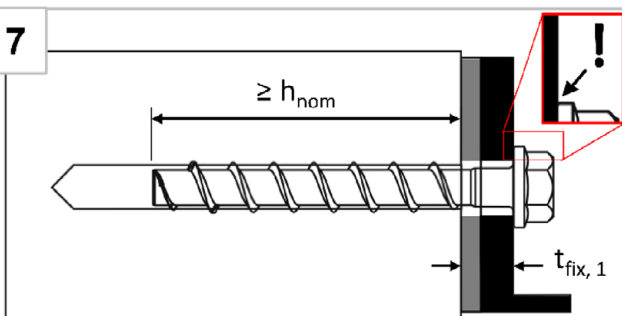

The head must be undamaged and in contact with the fixture

2. Adjustment

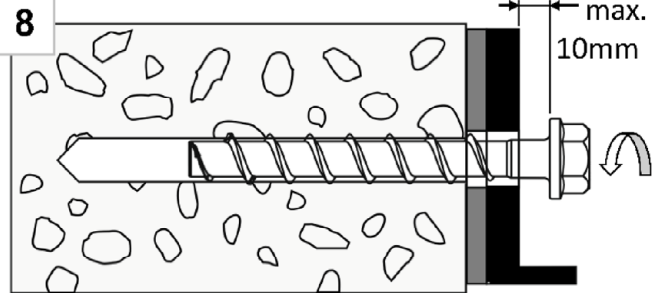

Screw may be untightened maximum 10mm

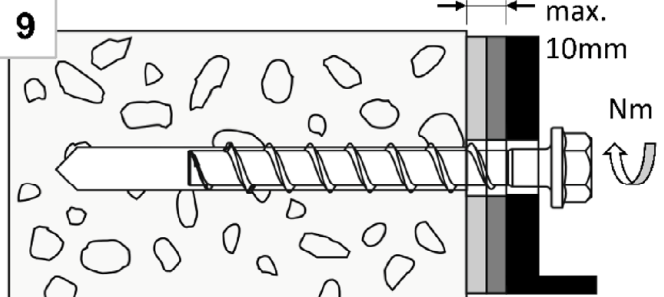

After adjustment, tighten the screw again

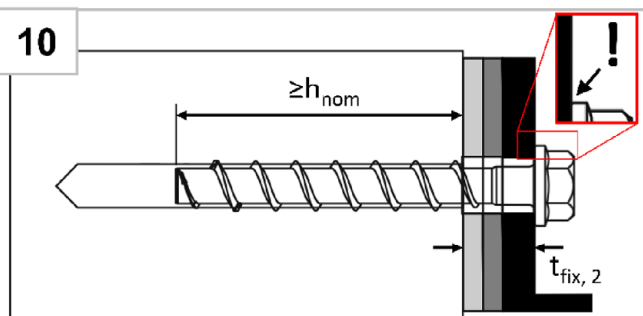

The head must be undamaged and in contact with the fixture

Note:

The fastener can be adjusted maximum two times. The total allowed thickness of shims added during the adjustment process is 10mm. The final embedment depth after adjustment process must be larger or equal than h_{nom} .

CELO concrete screw BTS

Intended use
Installation instructions - Adjustment

Annex B6

Installation Instructions – Filling annular gap

Positioning of fixture and filling washer

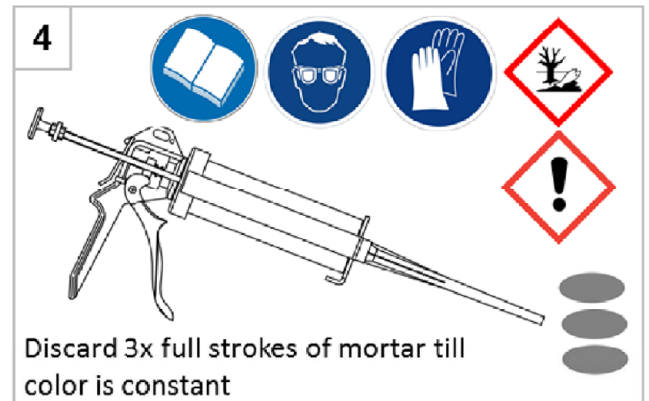
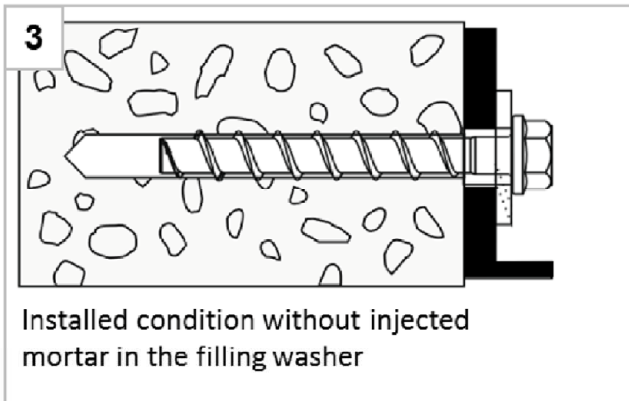
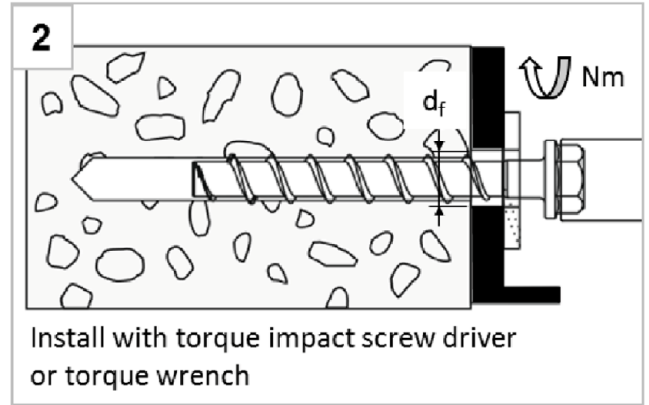
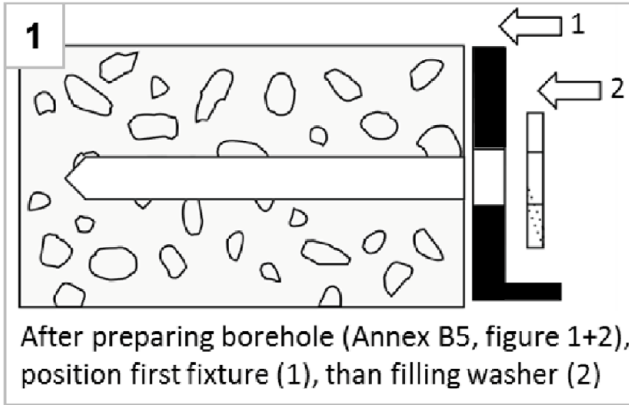

Filling the annular gap

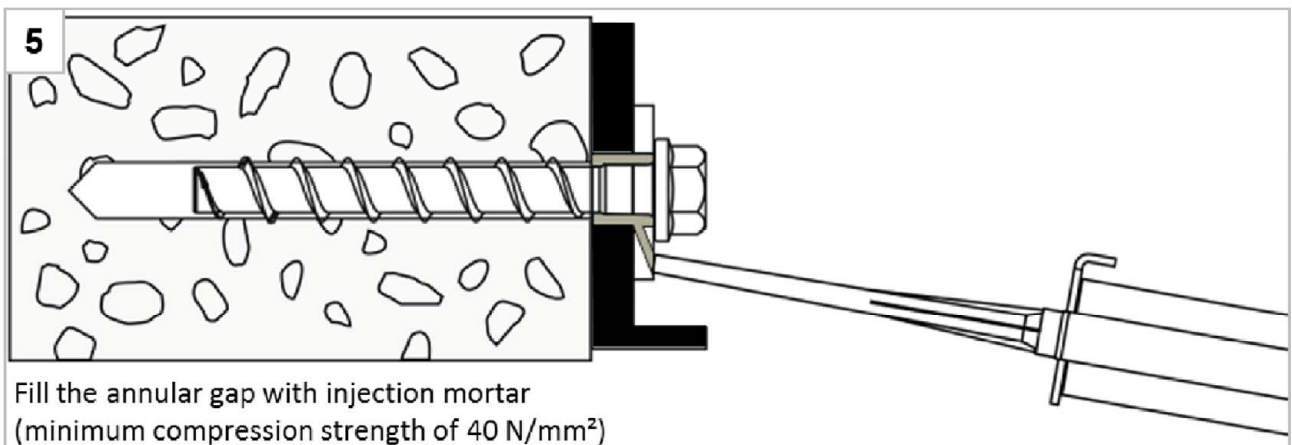

Note:

For seismic loading the installation with filled and without filled annular gap is approved. Differences in performance can be found in Annex C5 - C7.

CELO concrete screw BTS

Intended use

Installation instructions - Filling annular gap

Annex B7

Table 6: Characteristic values for static and quasi-static loading, sizes 6-10

BTS concrete screw size			6		8			10			
Nominal embedment depth	h_{nom}	h_{nom1}	h_{nom2}	h_{nom1}	h_{nom2}	h_{nom3}	h_{nom1}	h_{nom2}	h_{nom3}		
	[mm]	40	55	45	55	65	55	75	85		
Steel failure for tension and shear loading											
Characteristic tension load	$N_{Rk,s}$	[kN]	14,0		27,0			45,0			
Partial factor	$\gamma_{Ms,N}$	[-]	1,5								
Characteristic shear load	$V^0_{Rk,s}$	[kN]	7,0		13,5		17,0	22,5	34,0		
Partial factor	$\gamma_{Ms,V}$	[-]	1,25								
Ductility factor	k_7	[-]	0,8								
Characteristic bending load	$M^0_{Rk,s}$	[Nm]	10,9		26,0			56,0			
Pull-out failure											
Characteristic tension load C20/25	cracked	$N_{Rk,p}$	[kN]	2,0	4,0	5,0	9,0	12,0	9,0	$\geq N^0_{Rk,c}$ ¹⁾	
	uncracked	$N_{Rk,p}$	[kN]	4,0	9,0	7,5	12,0	16,0	12,0	20,0	26,0
Increasing factor for $N_{Rk,p}$	C25/30	Ψ_c	[-]	1,12							
	C30/37			1,22							
	C40/50			1,41							
	C50/60			1,58							
Concrete failure: Splitting failure, concrete cone failure and pry-out failure											
Effective embedment depth	h_{ef}	[mm]	31	44	35	43	52	43	60	68	
k-factor	cracked	k_{cr}	[-]	7,7							
	uncracked	k_{ucr}	[-]	11,0							
Concrete cone failure	spacing	$S_{cr,N}$	[mm]	3 x h_{ef}							
	edge distance	$C_{cr,N}$	[mm]	1,5 x h_{ef}							
Splitting failure	resistance	$N^0_{Rk,sp}$	[kN]	4,0	9,0	7,5	12,0	16,0	12,0	20,0	26,0
	spacing	$S_{cr,sp}$	[mm]	120	160	120	140	150	140	180	210
	edge distance	$C_{cr,sp}$	[mm]	60	80	60	70	75	70	90	105
Factor for pry-out failure	k_8	[-]	1,0						2,0		
Installation factor	γ_{inst}	[-]	1,0								
Concrete edge failure											
Effective length in concrete	$l_f = h_{ef}$	[mm]	31	44	35	43	52	43	60	68	
Nominal outer diameter of screw	d_{nom}	[mm]	6		8			10			

¹⁾ $N^0_{Rk,c}$ according to EN 1992-4:2018

CELO concrete screw BTS

Performances

Characteristic values for static and quasi-static loading, sizes 6-10

Annex C1

Table 7: Characteristic values for static and quasi-static loading, sizes 12-14

BTS concrete screw size			12			14			
Nominal embedment depth	h_{nom}		h_{nom1}	h_{nom2}	h_{nom3}	h_{nom1}	h_{nom2}	h_{nom3}	
	[mm]		65	85	100	75	100	115	
Steel failure for tension and shear loading									
Characteristic tension load	$N_{RK,s}$	[kN]	67,0			94,0			
Partial factor	$\gamma_{Ms,N}$	[-]	1,5						
Characteristic shear load	$V^0_{RK,s}$	[kN]	33,5	42,0		56,0			
Partial factor	$\gamma_{Ms,V}$	[-]	1,25						
Ductility factor	k_7	[-]	0,8						
Characteristic bending load	$M^0_{RK,s}$	[Nm]	113,0			185,0			
Pull-out failure									
Characteristic tension load C20/25	cracked	$N_{RK,p}$	[kN]	12,0	$\geq N^0_{RK,c}$ ¹⁾				
	uncracked	$N_{RK,p}$	[kN]	16,0					
Increasing factor for $N_{RK,p}$	C25/30	ψ_c	[-]	1,12					
	C30/37			1,22					
	C40/50			1,41					
	C50/60			1,58					
Concrete failure: Splitting failure, concrete cone failure and pry-out failure									
Effective embedment depth	h_{ef}	[mm]	50	67	80	58	79	92	
k-factor	cracked	$k_1 = k_{cr}$	[-]	7,7					
	uncracked	$k_1 = k_{ucr}$	[-]	11,0					
Concrete cone failure	spacing	$s_{cr,N}$	[mm]	$3 \times h_{ef}$					
	edge distance	$c_{cr,N}$	[mm]	$1,5 \times h_{ef}$					
Splitting failure	resistance	$N^0_{RK,sp}$	[kN]	16,0	27,0	35,0	21,5	34,5	43,5
	spacing	$s_{cr,sp}$	[mm]	150	210	240	180	240	280
	edge distance	$c_{cr,sp}$	[mm]	75	105	120	90	120	140
Factor for pry-out failure	k_8	[-]	1,0	2,0		1,0	2,0		
Installation factor	γ_{inst}	[-]	1,0						
Concrete edge failure									
Effective length in concrete	$l_f = h_{ef}$	[mm]	50	67	80	58	79	92	
Nominal outer diameter of screw	d_{nom}	[mm]	12			14			

¹⁾ $N^0_{RK,c}$ according to EN 1992-4:2018

CELO concrete screw BTS

Performances

Characteristic values for static and quasi-static loading, sizes 12-14

Annex C2

Table 8: Seismic category C1 – Characteristic load values (only BTS B, BTS K, BTS ST, BTS, BTS E ¹⁾ , BTS PT/PTL und BTS H ¹⁾)										
BTS concrete screw size			6	8	10	12	14			
Nominal embedment depth	h_{nom}	h_{nom1}	h_{nom2}	h_{nom3}	h_{nom1}	h_{nom3}	h_{nom3}	h_{nom3}		
	[mm]	40	55	65	55	85	100	115		
Steel failure for tension and shear load (version BTS B, BTS K, BTS ST, BTS, BTS E¹⁾, BTS PT/PTL, BTS H¹⁾)										
Characteristic load	$N_{RK,s,C1}$	[kN]	14,0	27,0	45,0	67,0	94,0			
Partial factor	$\gamma_{Ms,C1}$	[-]	1,5							
Characteristic load	$V_{RK,s,C1}$	[kN]	4,7	5,5	8,5	13,5	15,3	21,0	22,4	
Partial factor	$\gamma_{Ms,C1}$	[-]	1,25							
With filling of the annular gap ²⁾	α_{gap}	[-]	1,0							
Without filling of the annular gap ³⁾	α_{gap}	[-]	0,5							
Pull-out failure (version BTS B, BTS K, BTS ST, BTS, BTS E¹⁾, BTS PT/PTL, BTS H¹⁾)										
Characteristic tension load in cracked concrete C20/25	$N_{RK,p,C1}$	[kN]	2,0	4,0	12,0	9,0	$\geq N^0_{RK,c}$ ⁴⁾			
Concrete cone failure (version type S, type SK, type ST, type ST-6¹⁾, type P, type I¹⁾)										
Effective embedment depth	h_{ef}	[mm]	31	44	52	43	68	80	92	
Edge distance	$c_{cr,N}$	[mm]	$1,5 \times h_{ef}$							
Spacing	$s_{cr,N}$	[mm]	$3 \times h_{ef}$							
Installation safety factor	γ_{inst}	[-]	1,0							
Concrete pry-out failure (version BTS B, BTS K, BTS ST, BTS, BTS PT/PTL)										
Factor for pry-out failure	k_8	[-]	1,0				2,0			
Concrete edge failure (version BTS B, BTS K, BTS ST, BTS, BTS PT/PTL)										
Effective length in concrete	$l_f = h_{ef}$	[mm]	31	44	52	43	68	80	92	
Nominal outer diameter of screw	d_{nom}	[mm]	6	6	8	10	10	12	14	
¹⁾ only tension load ²⁾ With filling of the annular gap according to annex B7, figure 5 ³⁾ Without filling of the annular gap according to annex B5 ⁴⁾ $N^0_{RK,c}$ according to EN 1992-4:2018										
CELO concrete screw BTS								Annex C3		
Performances Seismic category C1 – Characteristic load values										

Table 9: Seismic category C2 ¹⁾ – Characteristic load values **with filled annular gap according to annex B7, figure 5** (only BTS B, BTS K, BTS, BTS PT/PTL)

BTS concrete screw size			8	10	12	14
Nominal embedment depth	h_{nom}	h_{nom3}				
	[mm]	65	85	100	115	
Steel failure for tension and shear load (version BTS B, BTS K, BTS, BTS PT/PTL)						
Characteristic load	$N_{RK,s,C2}$	[kN]	27,0	45,0	67,0	94,0
Partial factor	$\gamma_{Ms,C2}$	[-]	1,5			
Characteristic load	$V_{RK,s,C2}$	[kN]	9,9	18,5	31,6	40,7
Partial factor	$\gamma_{Ms,C2}$	[-]	1,25			
With filling of the annular gap	α_{gap}	[-]	1,0			
Pull-out failure (version BTS B, BTS K, BTS, BTS PT/PTL)						
Characteristic load in cracked concrete	$N_{RK,p,C2}$	[kN]	2,4	5,4	7,1	10,5
Concrete cone failure (version BTS B, BTS K, BTS, BTS PT/PTL)						
Effective embedment depth	h_{ef}	[mm]	52	68	80	92
Edge distance	$c_{cr,N}$	[mm]	1,5 x h_{ef}			
Spacing	$s_{cr,N}$	[mm]	3 x h_{ef}			
Installation safety factor	γ_{inst}	[-]	1,0			
Concrete pry-out failure (version BTS B, BTS K, BTS, BTS PT/PTL)						
Factor for pry-out failure	k_g	[-]	1,0	2,0		
Concrete edge failure (version BTS B, BTS K, BTS, BTS PT/PTL)						
Effective length in concrete	$l_f = h_{ef}$	[mm]	52	68	80	92
Nominal outer diameter of screw	d_{nom}	[mm]	8	10	12	14

1) A4 and HCR not suitable

CELO concrete screw BTS

Performances

Seismic category C2 – Characteristic load values with filled annular gap

Annex C4

Table 10: Seismic category C2 ¹⁾ – Characteristic load values **without filled annular gap according to annex B5** (only BTS B, BTS K, BTS, BTS PT/PTL, BTS ST)

BTS concrete screw size			8	10	12	14
Nominal embedment depth	h_{nom}	h_{nom3}				
	[mm]	65	85	100	115	
Steel failure for tension and shear load (version BTS B, BTS K, BTS, BTS PT/PTL)						
Characteristic load	$N_{Rk,s,C2}$	[kN]	27,0	45,0	67,0	94,0
Partial factor	$\gamma_{Ms,C2}$	[-]	1,5			
Characteristic load	$V_{Rk,s,C2}$	[kN]	10,3	21,9	24,4	23,3
Partial factor	$\gamma_{Ms,C2}$	[-]	1,25			
Without filling of the annular gap	α_{gap}	[-]	0,5			
Pull-out failure (version BTS B, BTS K, BTS, BTS PT/PTL)						
Characteristic load in cracked concrete	$N_{Rk,p,C2}$	[kN]	2,4	5,4	7,1	10,5
Steel failure for tension and shear load (version BTS ST)						
Characteristic load	$N_{Rk,s,C2}$	[kN]	27,0	45,0	no performance assessed	
Partial factor	$\gamma_{Ms,C2}$	[-]	1,5			
Characteristic load	$V_{Rk,s,C2}$	[kN]	3,6	13,7		
Partial factor	$\gamma_{Ms,C2}$	[-]	1,25			
Without filling of the annular gap	α_{gap}	[-]	0,5			
Pull-out failure (version BTS ST)						
Characteristic load in cracked concrete	$N_{Rk,p,C2}$	[kN]	2,4	5,4	no performance assessed	
Concrete cone failure (version BTS B, BTS K, BTS ST, BTS, BTS PT/PTL)						
Effective embedment depth	h_{ef}	[mm]	52	68	80	92
Edge distance	$c_{cr,N}$	[mm]	1,5 x h_{ef}			
Spacing	$s_{cr,N}$	[mm]	3 x h_{ef}			
Installation safety factor	γ_{inst}	[-]	1,0			
Concrete pry-out failure (version BTS B, BTS K, BTS ST, BTS, BTS PT/PTL)						
Factor for pry-out failure	k_g	[-]	1,0	2,0		
Concrete edge failure (version BTS B, BTS K, BTS ST, BTS, BTS PT/PTL)						
Effective length in concrete	$l_f = h_{ef}$	[mm]	52	68	80	92
Nominal outer diameter of screw	d_{nom}	[mm]	8	10	12	14

¹⁾ A4 and HCR not suitable

CELO concrete screw BTS

Performances

Seismic category C2 – Characteristic load values without filled annular gap

Annex C5

Table 11: Fire exposure – characteristic values of resistance

BTS concrete screw size				6		8			10			12			14			
Nominal embedment depth				h_{nom}	1	2	1	2	3	1	2	3	1	2	3	1	2	3
				[mm]	40	55	45	55	65	55	75	85	65	85	100	75	100	115
Steel failure for tension and shear load																		
characteristic Resistance	R30	$N_{Rk,s,fi30}$	[kN]	0,9	2,4			4,4			7,3			10,3				
	R60	$N_{Rk,s,fi60}$	[kN]	0,8	1,7			3,3			5,8			8,2				
	R90	$N_{Rk,s,fi90}$	[kN]	0,6	1,1			2,3			4,2			5,9				
	R120	$N_{Rk,s,fi120}$	[kN]	0,4	0,7			1,7			3,4			4,8				
	R30	$V_{Rk,s,fi30}$	[kN]	0,9	2,4			4,4			7,3			10,3				
	R60	$V_{Rk,s,fi60}$	[kN]	0,8	1,7			3,3			5,8			8,2				
	R90	$V_{Rk,s,fi90}$	[kN]	0,6	1,1			2,3			4,2			5,9				
	R120	$V_{Rk,s,fi120}$	[kN]	0,4	0,7			1,7			3,4			4,8				
	R30	$M^0_{Rk,s,fi30}$	[Nm]	0,7	2,4			5,9			12,3			20,4				
	R60	$M^0_{Rk,s,fi60}$	[Nm]	0,6	1,8			4,5			9,7			15,9				
	R90	$M^0_{Rk,s,fi90}$	[Nm]	0,5	1,2			3,0			7,0			11,6				
	R120	$M^0_{Rk,s,fi120}$	[Nm]	0,3	0,9			2,3			5,7			9,4				
Pull-out failure																		
Characteristic Resistance	R30- R90	$N_{Rk,p,fi}$	[kN]	0,5	1,0	1,3	2,3	3,0	2,3	4,0	4,8	3,0	4,7	6,2	3,8	6,0	7,6	
	R120	$N_{Rk,p,fi}$	[kN]	0,4	0,8	1,0	1,8	2,4	1,8	3,2	3,9	2,4	3,8	4,9	3,0	4,8	6,1	
Concrete cone failure																		
Characteristic Resistance	R30- R90	$N^0_{Rk,c,fi}$	[kN]	0,9	2,2	1,2	2,1	3,4	2,1	4,8	6,6	3,0	6,3	9,9	4,4	9,6	14,0	
	R120	$N^0_{Rk,c,fi}$	[kN]	0,7	1,8	1,0	1,7	2,7	1,7	3,8	5,3	2,4	5,1	7,9	3,5	7,6	11,2	
Edge distance																		
R30 bis R120		$c_{cr,fi}$	[mm]	$2 \times h_{ef}$														
In case of fire attack from more than one side, the minimum edge distance shall be ≥ 300 mm.																		
Spacing																		
R30 bis R120		$s_{cr,fi}$	[mm]	$4 \times h_{ef}$														
Pry-out failure																		
R30 bis R120		k_g	[-]	1,0			2,0			1,0	2,0		1,0	2,0				
The anchorage depth has to be increased for wet concrete by at least 30 mm compared to the given value.																		

CELO concrete screw BTS

Performances

Fire exposure – characteristic values of resistance

Annex C6

Table 12: Displacements under static and quasi-static tension load

BTS concrete screw size				6			8			10		
Nominal embedment depth			h_{nom}	h_{nom1}	h_{nom2}	h_{nom1}	h_{nom2}	h_{nom3}	h_{nom1}	h_{nom2}	h_{nom3}	
			[mm]	40	55	45	55	65	55	75	85	
Cracked concrete	tension load	N	[kN]	0,95	1,9	2,4	4,3	5,7	4,3	7,9	9,6	
	displacement	δ_{N0}	[mm]	0,3	0,6	0,6	0,7	0,8	0,6	0,5	0,9	
		$\delta_{N\infty}$	[mm]	0,4	0,4	0,6	1,0	0,9	0,4	1,2	1,2	
Uncracked concrete	tension load	N	[kN]	1,9	4,3	3,6	5,7	7,6	5,7	9,5	11,9	
	displacement	δ_{N0}	[mm]	0,4	0,6	0,7	0,9	0,5	0,7	1,1	1,0	
		$\delta_{N\infty}$	[mm]	0,4	0,4	0,6	1,0	0,9	0,4	1,2	1,2	

BTS concrete screw size				12			14		
Nominal embedment depth			h_{nom}	h_{nom1}	h_{nom2}	h_{nom3}	h_{nom1}	h_{nom2}	h_{nom3}
			[mm]	65	85	100	75	100	115
Cracked concrete	tension load	N	[kN]	5,7	9,4	12,3	7,6	12,0	15,1
	displacement	δ_{N0}	[mm]	0,9	0,5	1,0	0,5	0,8	0,7
		$\delta_{N\infty}$	[mm]	1,0	1,2	1,2	0,9	1,2	1,0
Uncracked concrete	tension load	N	[kN]	7,6	13,2	17,2	10,6	16,9	21,2
	displacement	δ_{N0}	[mm]	1,0	1,1	1,2	0,9	1,2	0,8
		$\delta_{N\infty}$	[mm]	1,0	1,2	1,2	0,9	1,2	1,0

Table 13: Displacements under static and quasi-static shear load

BTS concrete screw size				6			8			10		
Nominal embedment depth			h_{nom}	h_{nom1}	h_{nom2}	h_{nom1}	h_{nom2}	h_{nom3}	h_{nom1}	h_{nom2}	h_{nom3}	
			[mm]	40	55	45	55	65	55	75	85	
Cracked and uncracked concrete	shear load	V	[kN]	3,3			8,6			16,2		
	displacement	δ_{V0}	[mm]	1,55			2,7			2,7		
		$\delta_{V\infty}$	[mm]	3,1			4,1			4,3		

BTS concrete screw size				12			14		
Nominal embedment depth			h_{nom}	h_{nom1}	h_{nom2}	h_{nom3}	h_{nom1}	h_{nom2}	h_{nom3}
			[mm]	65	85	100	75	100	115
Cracked and uncracked concrete	shear load	V	[kN]	20,0			30,5		
	displacement	δ_{V0}	[mm]	4,0			3,1		
		$\delta_{V\infty}$	[mm]	6,0			4,7		

CELO concrete screw BTS

Performances
Displacements under static and quasi-static loads

Annex C7

Table 14: Seismic category C2 ¹⁾ – Displacements **with filled annular gap**
according to annex B7, figure 5 (only version BTS B, BTS K, BTS, BTS PT/PTL)

BTS concrete screw size			8	10	12	14
Nominal embedment depth	h_{nom}	h_{nom3}				
	[mm]	65	85	100	115	
Displacements under tension loads (version Typ B, BTS K, BTS, BTS PT/PTL)						
Displacement DLS	$\delta_{N,C2(DLS)}$	[mm]	0,66	0,32	0,57	1,16
Displacement ULS	$\delta_{N,C2(ULS)}$	[mm]	1,74	1,36	2,36	4,39
Displacements under shear loads (version Typ B, BTS K, BTS, BTS PT/PTL with hole clearance)						
Displacement DLS	$\delta_{V,C2(DLS)}$	[mm]	1,68	2,91	1,88	2,42
Displacement ULS	$\delta_{V,C2(ULS)}$	[mm]	5,19	6,72	5,37	9,27

Table 15: Seismic category C2 ¹⁾ – Displacements **without filled annular gap**
according to annex B5 (only version type S, type SK, type ST, type P)

BTS concrete screw size			8	10	12	14
Nominal embedment depth	h_{nom}	h_{nom3}				
	[mm]	65	85	100	115	
Displacements under tension loads (version BTS B, BTS K, BTS, BTS PT/PTL)						
Displacement DLS	$\delta_{N,C2(DLS)}$	[mm]	0,66	0,32	0,57	1,16
Displacement ULS	$\delta_{N,C2(ULS)}$	[mm]	1,74	1,36	2,36	4,39
Displacements under tension loads (version BTS ST)						
Displacement DLS	$\delta_{N,C2(DLS)}$	[mm]	0,66	0,32	no performance assessed	
Displacement ULS	$\delta_{N,C2(ULS)}$	[mm]	1,74	1,36		
Displacements under shear loads (version BTS B, BTS K, BTS, BTS PT/PTL with hole clearance)						
Displacement DLS	$\delta_{V,C2(DLS)}$	[mm]	4,21	4,71	4,42	5,60
Displacement ULS	$\delta_{V,C2(ULS)}$	[mm]	7,13	8,83	6,95	12,63
Displacements under shear loads (version BTS ST with hole clearance)						
Displacement DLS	$\delta_{V,C2(DLS)}$	[mm]	2,51	2,98	no performance assessed	
Displacement ULS	$\delta_{V,C2(ULS)}$	[mm]	7,76	6,25		

¹⁾ A4 and HCR not suitable

CELO concrete screw BTS

Performances
Displacements under seismic loads

Annex C8